



E.H. Wachs
600 Knightsbridge Parkway
Lincolnshire, IL 60069
www.ehwachs.com

HPU-20 Hydraulic Power Unit User's Manual



E.H. Wachs Part No. 14-MAN-35
Revision 0, June 2016

IMPORTANT: Read this manual carefully
before starting and operating the power unit.

Copyright © 2016 E.H. Wachs. All rights reserved.
This manual may not be reproduced in whole or in part
without the written consent of E.H. Wachs.

Table of Contents

Chapter 1: About the HPU-20	1
Features	1
Specifications	5
Chapter 2: Safety	7
Operator Safety	7
Safety Symbols	8
Protective Equipment Requirements	9
Safety Procedures	9
Safety Labels	11
Chapter 3: Using the HPU-20	13
Lifting and Moving the HPU	13
Set-Up Instructions	14
Fill the Hydraulic Reservoir	14
Connect Power	15
Connect Hydraulic Hoses	16
Operating Instructions	17
Operating Notes	19
Cautions	19
Maintenance	19
Troubleshooting	21
Hydraulic	21
Electrical	22
Schematic	23
Chapter 4: Ordering Information	25
Ordering Replacement Parts	25
Repair Information	25
Warranty Information	26
Return Goods Address	26

Chapter 1

About the HPU-20

.....

The Wachs HPU-20 hydraulic power unit provides 18 gpm hydraulic flow at a maximum pressure of 1800 psi (57 l/min at 124 bar). The unit is powered by a 20 HP electric motor.

Before operating the unit, read and understand the instructions in this manual.

FEATURES

The HPU-20 hydraulic power unit includes the following standard features:

- 20 HP electric motor (380-460 V, 50/60 Hz).
- Line reactor to suppress noise.
- Over Temp/Low Oil warning light.
- Pendant with controls for power on/off, speed (flow), flow direction, and emergency stop.
- Removable mobile base with non-marring casters.
- Five-point lifting system.
- 10 micron hydraulic oil filter.
- Heat exchanger with digital readout.
- Helical cut, ultra quiet hydraulic gear pump.
- Powder coat finish.

The following figures illustrate the features of the HPU-20 power unit.

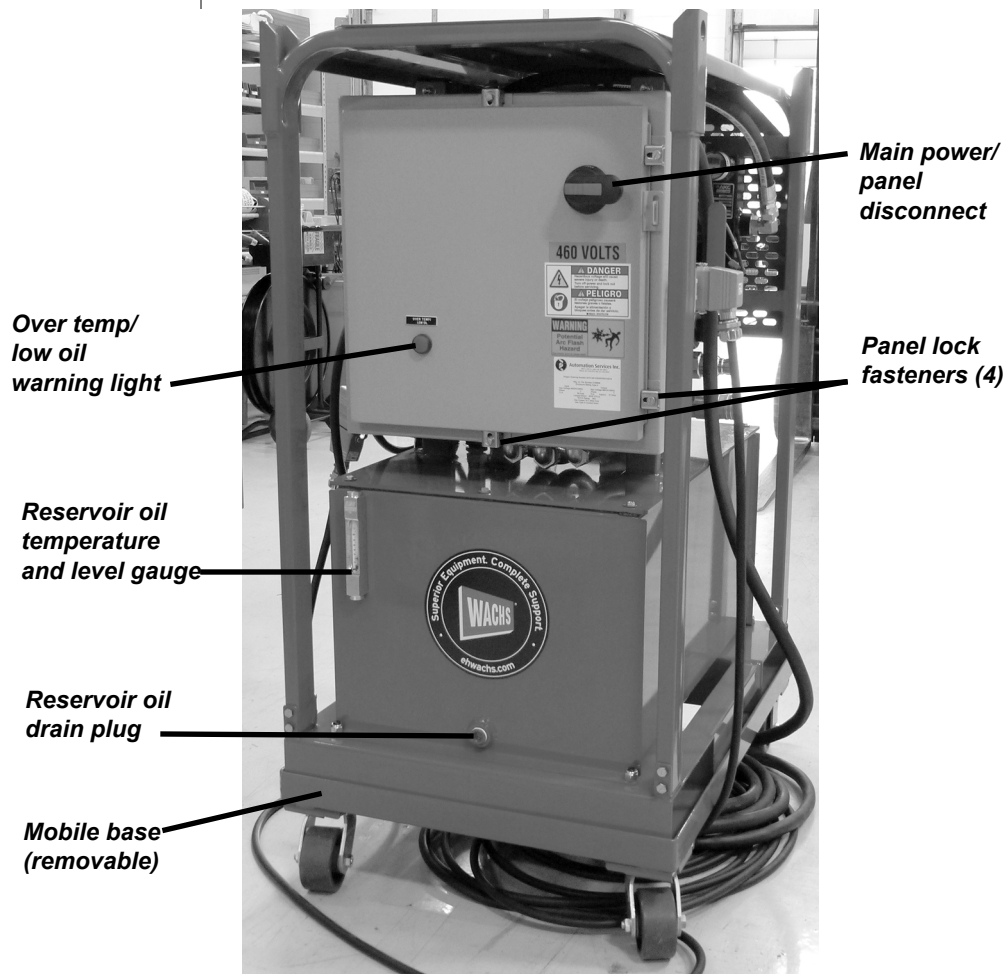

Figure 1-1. The photo shows the front of the HPU-20.

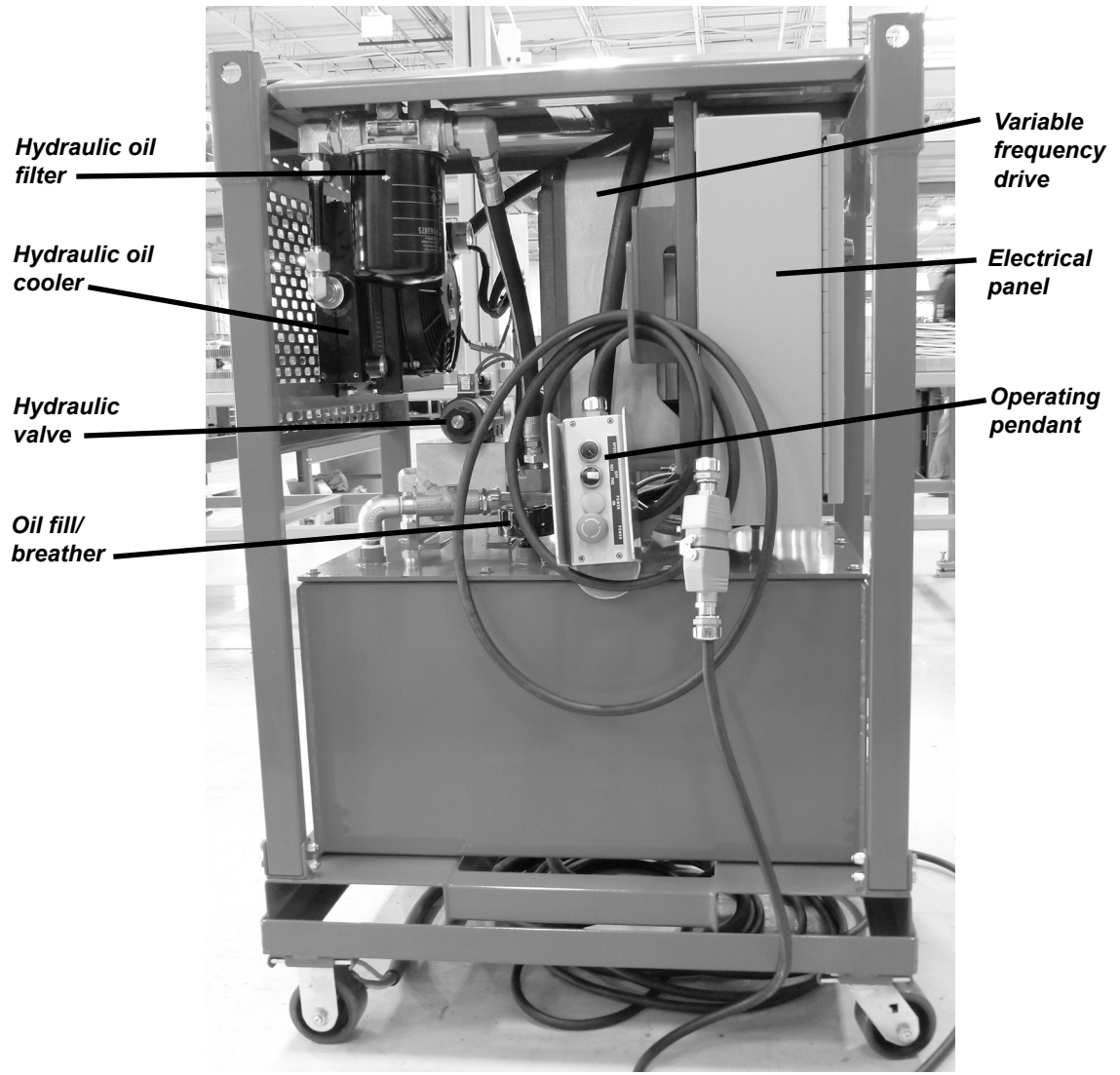

Figure 1-2. The photo shows operating features of the HPU-20.

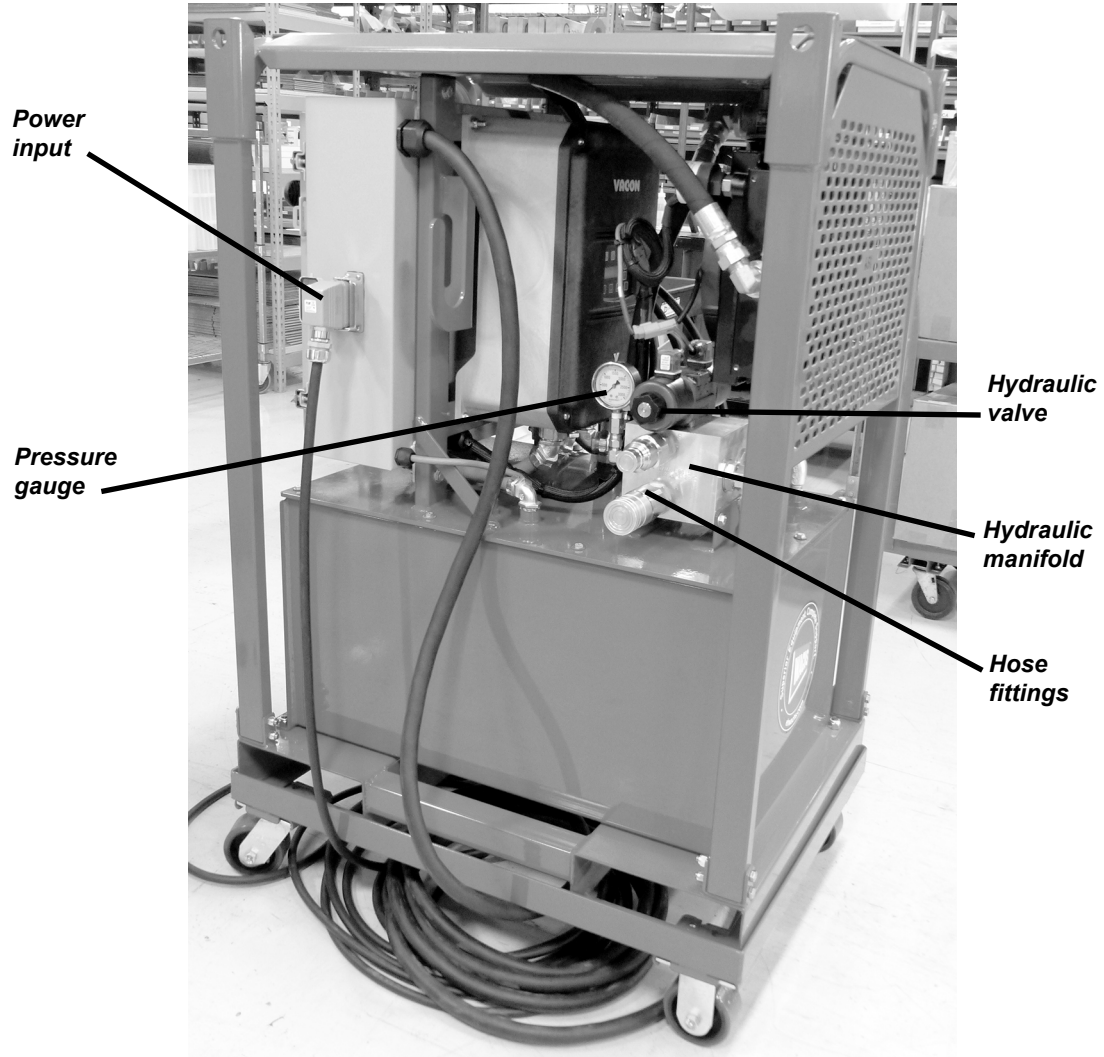

Figure 1-3. The photo shows operating features of the HPU-20.

Figure 1-4.



Pressure port:
1/2" NPT adapter (part no. 90-058-12) and male quick disconnect (part no. 09-026-00)

Return (tank) port:
1/2" NPT adapter (part no. 90-058-12) and female quick disconnect (part no. 09-025-00)

Figure 1-5. The drawing identifies the hydraulic fittings on the HPU-20.

SPECIFICATIONS

- **Flow:** 4-18 gpm @ 1800 psi (15-68 l/min @ 124 bar)
- **Pressure:** Factory set at 1800 psi (124 bar)
- **Dimensions (with base):** 34.5" l x 52.5" h x 26" w (88 cm x 133 cm x 66 cm)
- **Weight:** 850 lb (386 kg), including oil and mobile base
- **Hydraulic Oil Capacity:** 30 gallons (114 liters)
- **Hydraulic Relief Pressure:** 1800 psi (124 bar)
- **Current Draw:** 30 amps
- **Operating Temperature:** 110° F (43° C)
- **Noise Level:** 62 dB at full flow and operation.



Chapter 2

Safety

E.H. Wachs takes great pride in designing and manufacturing safe, high-quality products. We make user safety a top priority in the design of all our products.

Read this chapter carefully before operating the hydraulic power unit. It contains important safety instructions and recommendations.

OPERATOR SAFETY

Follow these guidelines for safe operation of the equipment.

- **READ THE OPERATING MANUAL.** Make sure you understand all setup and operating instructions before you begin.
- **INSPECT MACHINE AND ACCESSORIES.** Before starting the machine, look for loose bolts or nuts, leaking lubricant, rusted components, and any other physical conditions that may affect operation. Properly maintaining the machine can greatly decrease the chances for injury.
- **ALWAYS READ PLACARDS AND LABELS.** Make sure all placards, labels, and stickers are clearly legible and in good condition. You can purchase replacement labels from E.H. Wachs Company.
- **KEEP CLEAR OF MOVING PARTS.** Keep hands, arms, and fingers clear of all rotating or moving parts.

In This Chapter

OPERATOR SAFETY



Look for this symbol throughout the manual. It indicates a personal injury hazard.

Always turn machine off before doing any adjustments or service.

- **SECURE LOOSE CLOTHING AND JEWELRY.** Secure or remove loose-fitting clothing and jewelry, and securely bind long hair, to prevent them from getting caught in moving parts of the machine.
- **KEEP WORK AREA CLEAR.** Keep all clutter and nonessential materials out of the work area. Only people directly involved with the work being performed should have access to the area.

Safety Symbols



This icon is displayed with any safety alert that indicates a personal injury hazard.

WARNING

This safety alert indicates a potentially hazardous situation that, if not avoided, **could** result in **death or serious injury**.

CAUTION

This safety alert, with the personal injury hazard symbol, indicates a potentially hazardous situation that, if not avoided, **could** result in **minor or moderate injury**.

NOTICE

This alert indicates a situation that, if not avoided, **will** result in **damage to the equipment**.

IMPORTANT

This alert indicates a situation that, if not avoided, **may** result in **damage to the equipment**.

Protective Equipment Requirements

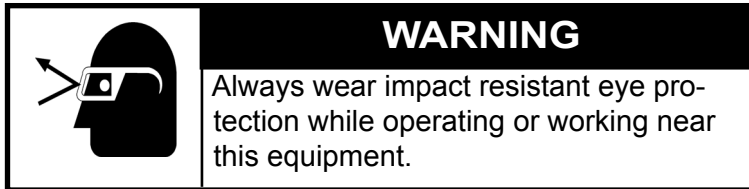

For additional information on eye and face protection, refer to Federal OSHA regulations, 29 Code of Federal Regulations, Section 1910.133., Eye and Face Protection and American National Standards Institute, ANSI Z87.1, Occupational and Educational Eye and Face Protection. Z87.1 is available from the American National Standards Institute, Inc., 1430 Broadway, New York, NY 10018.

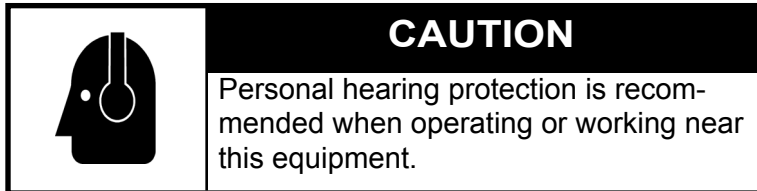

Hearing protectors are required in high noise areas, 85 dBA or greater. The operation of other tools and equipment in the area, reflective surfaces, process noises, and resonant structures can increase the noise level in the area. For additional information on hearing protection, refer to Federal OSHA regulations, 29 Code of Federal Regulations, Section 1910.95, Occupational Noise Exposure and ANSI S12.6 Hearing Protectors.

Safety Procedures

All safety requirements listed below are those generally applicable to hydraulically-powered machinery but are not intended to be an all-inclusive list. They are intended as guidelines only and will assist in avoiding risk of injury when followed by qualified, experienced personnel. These

WARNING

Many types of machinery have parts that may start moving as soon as the hydraulic circuit is filled and pressurized. This could result in injury to personnel or damage to machinery.



WARNING

Make sure all personnel are clear from the machinery being operated before shutting down the HPU.



precautions should be included in the comprehensive safety program for the particular machinery, equipment, plant or process and overseen by personnel capable of analyzing any hazards associated with operating and maintaining the equipment.

- 1.** Return all movable parts of the machinery being operated to their normal startup condition, if possible, before starting unit.
- 2.** Be sure all personnel, product, etc. are clear of machinery before starting hydraulic unit.
- 3.** Check to make sure any hydraulic connections which may have been removed, replaced or disconnected during shut down have been reconnected securely before starting hydraulic unit.
- 4.** Before starting the unit, perform all equipment checks described at the beginning of the operating instructions.
- 5.** If there are tools or machinery being operated by the HPU that may move when hydraulic flow or pressure are turned off or turned on, block or lock these parts in position before shutting down the hydraulic unit.
- 6.** Shut down the hydraulic unit and relieve pressure from all pressurized accumulators, actuators and lines before removing, tearing down or performing maintenance on any remotely-located actuators, hoses, filters, valves, piping, etc.
- 7.** Any personnel observing or working on or adjacent to hydraulically-powered equipment must never place themselves in a location or position that could produce an injury in the event of:
 - a hydraulic line failure either with the unit running or shut down;
 - pump or motor failure or;
 - pin-hole leaks in hoses or fittings;
 - movement of machine components during normal operation or resulting from a component malfunction or failure.

- 8.** Do not inspect hoses and fittings for leaks using your bare hands. A pin-hole leak can inject hydraulic fluid through the skin, with the potential for serious injury.
- 9.** Avoid locating equipment in any environment for which it was not designed and which may create a dangerous operating condition such as an explosive atmosphere (e.g., gas, dust), high heat (e.g., molten metal, furnace), chemicals, extreme moisture, etc.
- 10.** Avoid bodily contact with hydraulic fluids. Some hydraulic fluids may irritate or injure the eyes and skin. Check with your fluid suppliers to obtain this information.
- 11.** Use only E.H. Wachs parts and materials when servicing the equipment. Substitute parts or materials could produce a hazardous operating condition.
- 12.** When piping your equipment, use only materials of adequate size and strength to suit the flows and pressures of the system. Consider all safety factors when selecting the strength of materials to allow for shock and over-pressure conditions which could occur.

**WARNING**

The injection of hydraulic fluid under the skin can cause serious injury and even result in death. If an injection injury occurs, seek medical treatment immediately.

SAFETY LABELS

Safety labels on the front panel of the unit indicate the electrical hazards.

- Hazardous voltages can cause severe injury or death.
- An arc flash can cause severe injury or death.

Disconnect power from the HPU before opening the cabinet or performing any service on it.



Figure 2-1. Labels on the front panel warn of electrical hazards.

Chapter 3

Using the HPU-20

LIFTING AND MOVING THE HPU

The HPU-20 is supplied with a mobile base on caster wheels. The base can be removed from the unit.

The bottom of the HPU-20 frame has channels for lifting with a fork truck.

There are 5 lift points on top of the HPU-20 frame, one at each corner and one in the center. Attach to these points when lifting with an overhead crane.



Figure 3-1. Use the lift points on top of the frame.

SET-UP INSTRUCTIONS

The HPU-20 power unit is completely assembled before delivery. For safe shipping, it is delivered without hydraulic fluid.

NOTE: It is extremely important that the pump is not started until oil is in the system. Power units are shipped without oil. Operating a pump without oil, even for a short time, will result in damage.

Fill the Hydraulic Reservoir

Fill the hydraulic reservoir with hydraulic oil. The HPU-20 holds approximately 30 gallons (114 l). Make sure you fill the reservoir before starting the power unit.

Use an ISO-AW32 (preferred) or ISO-AW46 oil. Oil should have anti-wear characteristics, excellent rust protection, and contain additives to protect against foaming.



Figure 3-2. Remove the hydraulic reservoir cap and fill the reservoir with hydraulic oil (approximate capacity 30 gallons [114 l]).



Figure 3-3. Fill the reservoir to the level indicated on the oil level/temperature gauge.

Wipe up any spilled oil and replace the cap tightly. Do not operate the power unit without the cap securely in place.

Connect Power

Connect power to the HPU-20 at the connector on the side of the electrical panel. The unit can operate on 380-460 V, 50/60 Hz.

The input voltage limit is 380-460 V, +/- 15% (325-530 V).



Figure 3-4. Attach power to the connector on the electrical panel of the HPU-20.

NOTE: The power unit is factory-set to operate at 1800 psi (124 bar). It is extremely important that the hoses used with this unit are rated for 3000 psi (186 bar) or higher pressure.

Connect Hydraulic Hoses

Connect the hoses to the quick disconnect fittings as shown.

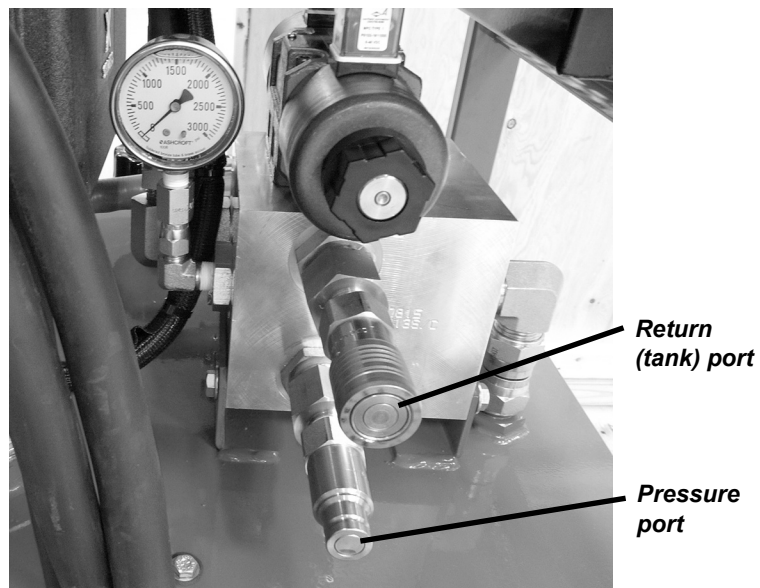

Figure 3-5. Connect the hydraulic hoses to the fittings as shown.

Note: Never connect or disconnect quick couplers when the HPU is on. Never connect or disconnect quick couplers when the circuit is under pressure. See the pressure gauge.

OPERATING INSTRUCTIONS

Before starting the power unit, perform the following checks:

- Make sure the reservoir is filled to the required level with hydraulic oil.
 - Make sure the cabinet door is secured with the panel lock fasteners.
 - Make sure the power cable is securely connected to the electrical cabinet.
 - Make sure the handheld control pendant is connected.
- 1.** Turn the flow control knob to the OFF position (all the way counter-clockwise).



Figure 3-6. Turn the main switch on the front of the cabinet to the ON position.

- 2.** On the handheld pendant, turn the POWER knob counter-clockwise until the POWER ON indicator lights up.

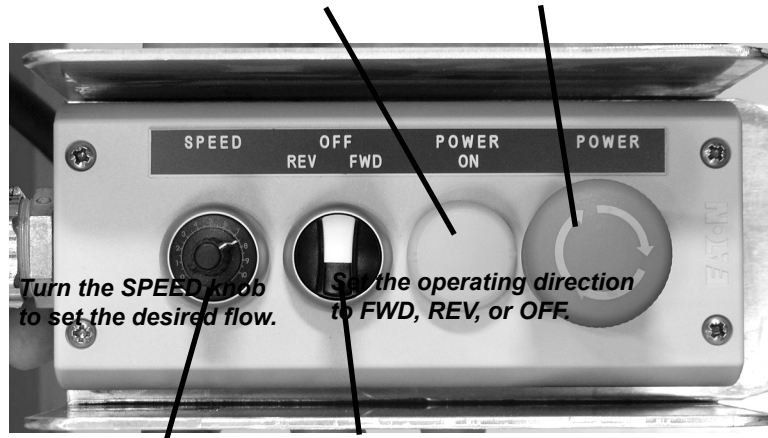

Figure 3-7. Operate the HPU using the handheld control pendant.

- 3.** To operate the tool, set the operating direction knob to the FWD position.
- 4.** Turn the SPEED knob clockwise to start hydraulic flow. Adjust the knob for the desired operating speed.
- 5.** To stop the motor, turn the operating direction knob to the OFF position. You can leave the SPEED knob at the same position; this will resume the same speed when you restart the motor.
- 6.** Operating the HPU without a hydraulic tool connected will pump oil over the relief valve, creating heat. If the unit overheats (above 180° F/82° C), it will shut down automatically, and the Over Temp/Low Oil indicator on the panel will light up.
- 7.** If the unit gets low on oil, it will shut down automatically, and the Over Temp/Low Oil indicator on the panel will light up.

Operating Notes

Make sure that the hydraulic circuit is properly plumbed and appropriate for the available amount of oil from the unit. A circuit with long hoses or a high-capacity tool could lower the reservoir level considerably. The power unit must be plumbed to an open center valve.

If the hydraulic circuit is improperly plumbed, pressure will build immediately and dump over the relief valve setting, causing excessive heat.

Cautions

Escaping hydraulic fluid under pressure can have sufficient force to penetrate skin, causing serious personal injury. Before disconnecting lines, be sure to relieve all pressure. Before applying pressure to the system, be sure all connections are tight and that lines and hoses are not damaged. Fluid escaping from a very small hole can be almost invisible. Use a piece of cardboard or wood rather than hands to search for suspected leaks.

If injured by escaping fluid, SEE A DOCTOR AT ONCE. Serious infection or reaction can develop if proper medical treatment is not administered immediately.

See the safety guidelines in the next chapter.

MAINTENANCE

Every time you use the power unit, inspect all fasteners, hydraulic hoses, and fittings.

Every time you use the power unit, check the hydraulic oil level in the reservoir. Check the oil level periodically during extended use.

Check the condition of the hydraulic fluid, looking for contaminants, dirt, or discoloration. Change the fluid as soon as it becomes dirty or discolored. It is recommended that you change the oil every 200 hours of operation.

NOTE: A hydraulic hose failure could be very hazardous; frequent inspection is important.

The hydraulic system includes a return line filter. Replace the filter every time you replace the hydraulic fluid. Do not try to get extended life out of a clogged filter.

Refer to the following chart for hydraulic oil service.

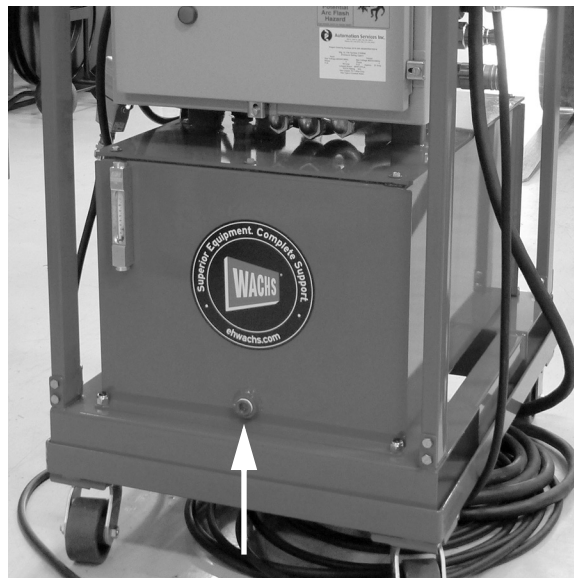
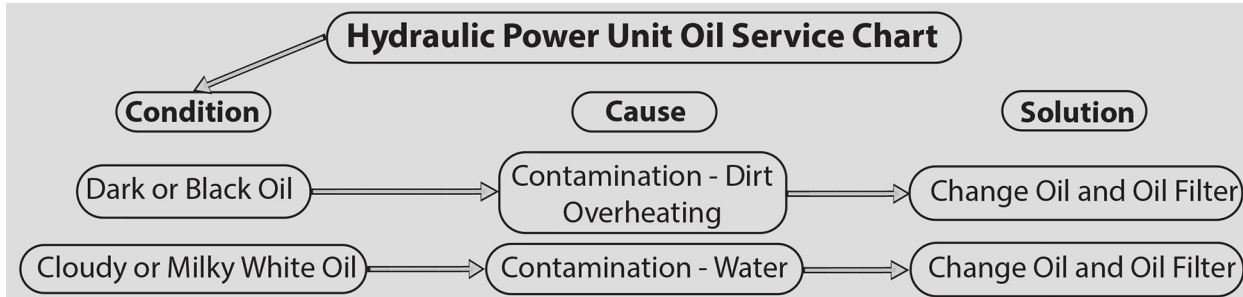

Figure 3-9. The hydraulic oil drain plug is at the bottom of the oil reservoir, on the front of the unit.

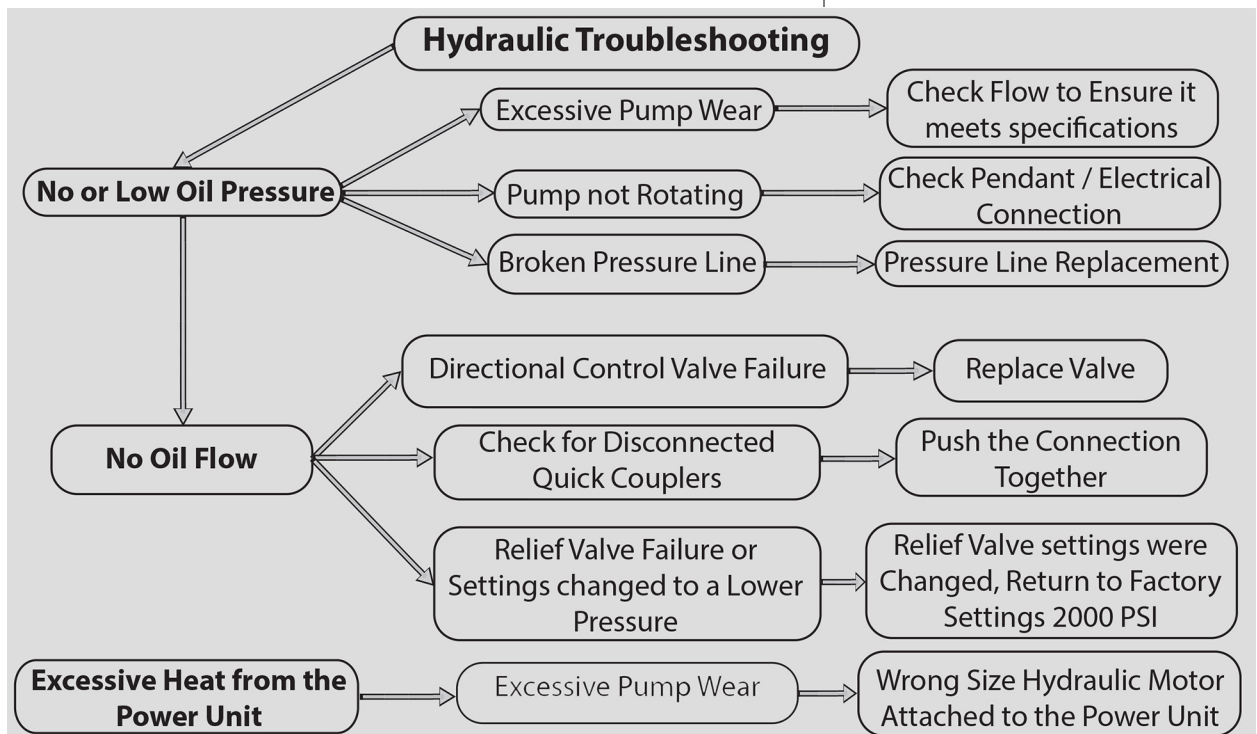

Figure 3-10. Replace the hydraulic oil filter every time you replace the hydraulic oil.

TROUBLESHOOTING

Hydraulic

Refer to the chart below for hydraulic troubleshooting.



Electrical

Electrical system troubleshooting and repair should be performed by trained and certified electrical staff. Electrical hazards can result in severe injury or death. Always consult E.H. Wachs if there are problems that are beyond the scope of available electrical staff.

Refer to the following notes and chart for electrical system troubleshooting.

- Make sure there are 3 good legs of power, within the specified power range.
- Make sure all fuses and circuit breakers are not tripped or blown.
- Check that the disconnect is turned off.
- Check the connect to the handheld pendant.
- Make sure the Stop button on the pendant is in the “Out” position.
- Make sure the Variable Frequency Drive is in the “Remote” setting. See the VFD drive manual.
- Make sure the Over Temp/Oil Level indicator is off.

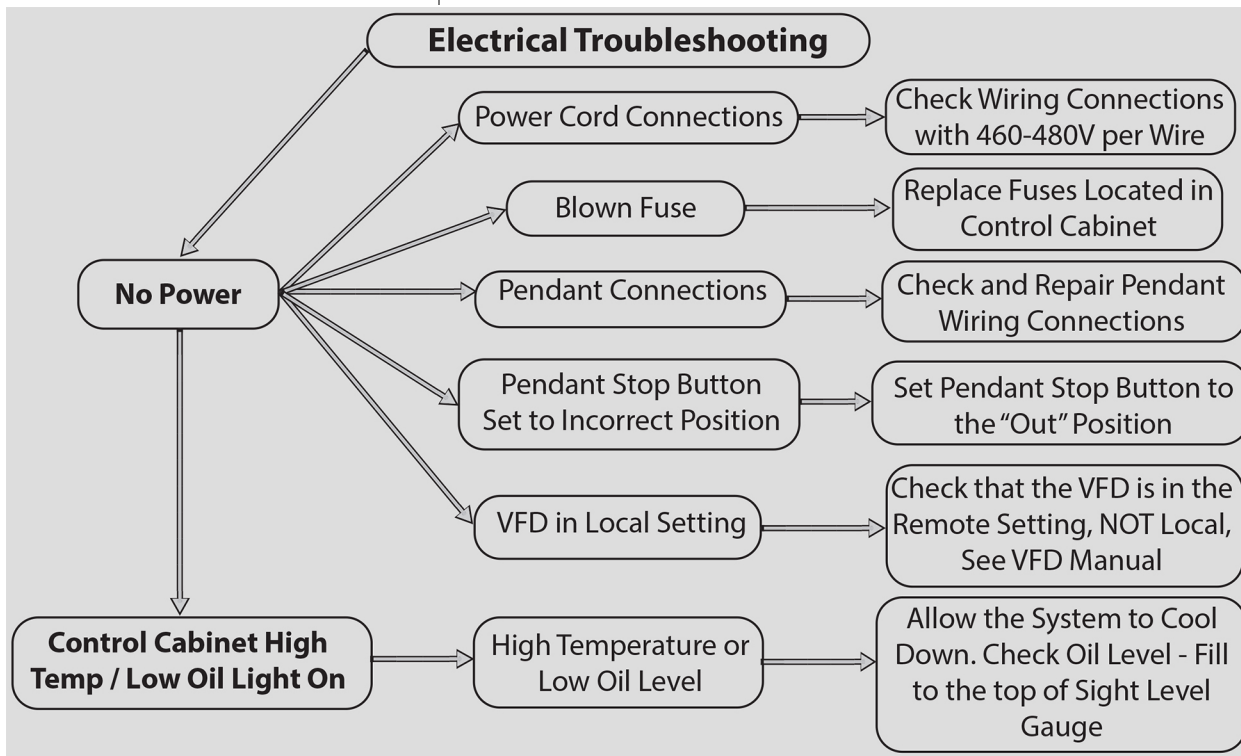

Schematic

Refer to the system schematic on the following page for troubleshooting and repair.

Pos.	Qty.	Type	Description	Manufacturer	Remark
100	1	G47V040CCFSAEBT13UD	Fixed Displacement Gear Pump	Settima	
105	1	SA-G03-C4-D2-E22	Wet Type Solenoid Valve	Nachi	
110	1	SJ-RVP	16 size, 1 5/16-12 thread	Delta Power	
115	1	63-3005HL 02L-3000#	0-3000 PSI 2 1/2" Pressure Gauge	Ashcroft	
120	1	AKG D10-24B	Oil to Air Cooler with DC Motor	AKG	Reverse Fan Blades
125	1	P166438 & P166875	HBK05 SAE Head	Donaldson	
130	1	AKG TCP2 Dual	Temp Switch	AKG	

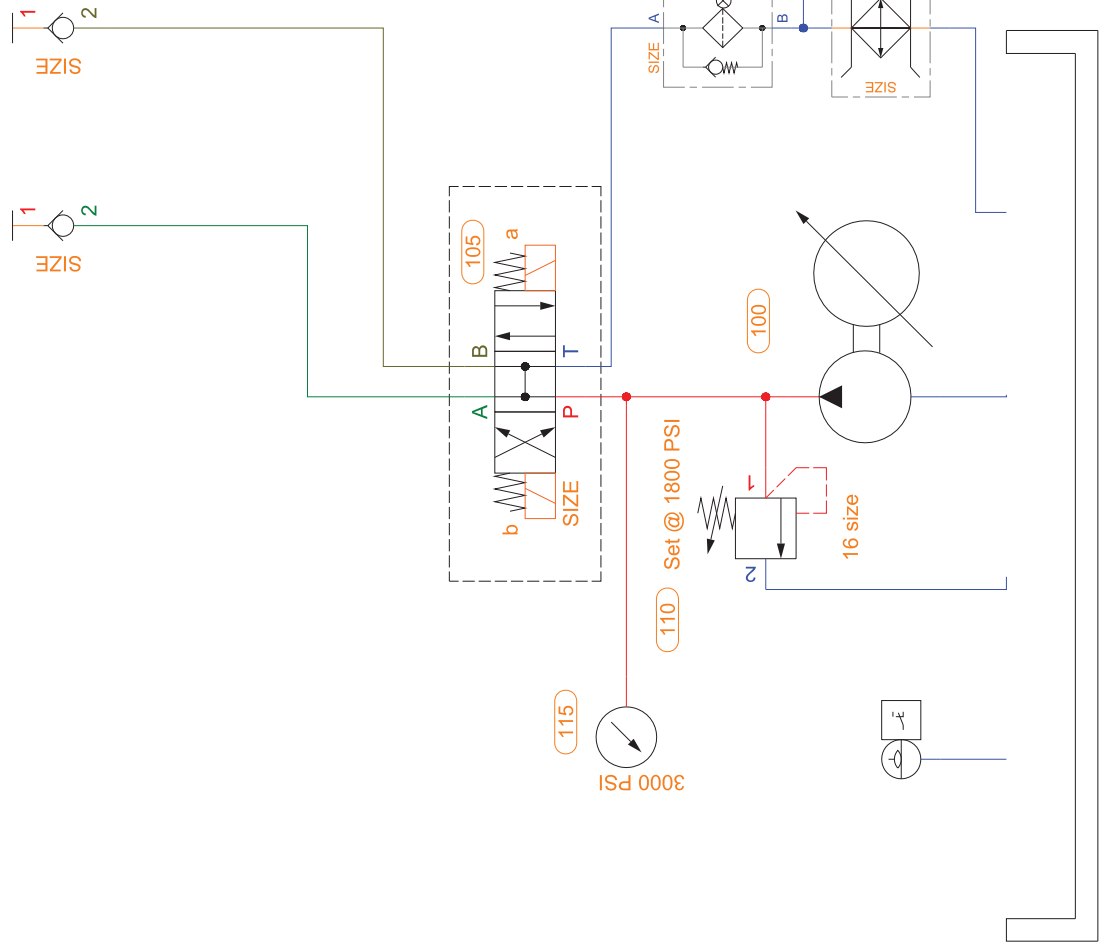

Chapter 4

Ordering Information

.....

To place an order, request service, or get more detailed information on any E.H. Wachs products, call us at one of the following numbers:

U.S. 800-323-8185
International: 847-537-8800

You can also visit our Web site at:

www.ehwachs.com

ORDERING REPLACEMENT PARTS

When ordering parts, refer to the drawings and parts lists on the following pages. Please provide the part description and part number for all parts you are ordering.

REPAIR INFORMATION

Please call us for an authorization number before returning any equipment for repair or factory service. We will advise you of shipping and handling. When you send the equipment, please include the following information:

- Your name/company name
- Your address
- Your phone number
- A description of the problem or the work to be done.

In This Chapter

ORDERING REPLACEMENT PARTS

REPAIR INFORMATION

WARRANTY INFORMATION

RETURN GOODS ADDRESS

Before we perform any repair, we will estimate the work and inform you of the cost and the time to complete it.

WARRANTY INFORMATION

Enclosed with the manual is a warranty card. Please fill out the registration card and return to E.H. Wachs. Retain the owner's registration record and warranty card for your information.

RETURN GOODS ADDRESS

Return equipment for repair to the following address.

E.H. Wachs
600 Knightsbridge Parkway
Lincolnshire, Illinois 60069 USA